

DEEBOT MINI™

EN Instruction Manual



Congratulations on the purchase of your ECOVACS ROBOTICS DEEBOT! We hope it brings you many years of satisfaction. We trust the purchase of your new robot will help keep your home clean and provide you more quality time to do other things.

Live Smart. Enjoy Life.

Should you encounter situations that have not been properly addressed in this Instruction Manual, please contact our Customer Service Center where a technician can address your specific problem or question.

For more information, please visit the ECOVACS ROBOTICS official website:
www.ecovacs.com

The company reserves the right to make technological and/or design changes to this product for continuous improvement.

Thank you for choosing DEEBOT!

Contents

1. Important Safety Instructions	2
2. Package Contents and Technical Specifications	4
2.1 Package Contents.....	4
2.2 Specifications.....	4
2.3 Product Diagram.....	5
3. Operating and Programming	7
3.1 Notes Before Cleaning.....	7
3.2 Quick Start.....	8
3.3 Cleaning Mode Selection.....	11
3.4 Intelligent Scheduling.....	12
3.5 Alarm Indicator and Sounds.....	13
4. Maintenance	14
4.1 Dust Bin and Filters.....	14
4.2 Washable/Reusable Microfiber Cleaning Cloth and Cleaning Cloth Plate.....	15
4.3 Suction Intake and Side Brushes.....	16
4.4 Other Components.....	16
5. Troubleshooting	17

1. Important Safety Instructions

When using an electrical appliance, basic precautions should always be followed, including the following:

READ ALL INSTRUCTIONS BEFORE USING THIS APPLIANCE.

SAVE THESE INSTRUCTIONS

1. This Appliance is not intended to be used by children under 8 or anyone lacking knowledge on proper use. Supervision may be necessary. Do not allow children to sit on or play with the Appliance.
2. Clear the area to be cleaned. Remove power cords and small objects from the floor that could entangle the Appliance. Tuck rug fringe under the rug base, and lift items such as curtains and tablecloths off the floor.
3. If there is a drop off in the cleaning area due to a step or stairs, you should operate the Appliance to ensure that it can detect the step without falling over the edge. It may become necessary to place a physical barrier at the edge to keep the unit from falling. Make sure the physical barrier is not a trip hazard.
4. Only use as described in this manual. Only use attachments recommended or sold by the manufacturer.
5. Please make sure your power supply voltage matches the power voltage marked on the Charging Dock.
6. For INDOOR household use ONLY. Do not use the Appliance in outdoor, commercial or industrial environments.
7. Use only the original rechargeable battery and Charging Dock provided with the Appliance from the manufacturer. Non-rechargeable batteries are prohibited. For battery information, please refer to Specifications section.
8. Do not use without dust bin and/or filters in place.
9. Do not operate the Appliance in an area where there are lit candles or fragile objects.
10. Do not use in extremely hot or cold environments (below -5°C/23°F or above 40°C/104°F).
11. Keep hair, loose clothing, fingers, and all parts of body away from any openings and moving parts.
12. Do not operate the Appliance in a room where an infant or child is sleeping.
13. Do not use Appliance on wet surfaces or surfaces with standing water.
14. Do not allow the Appliance to pick up large objects like stones, large pieces of paper or any item that may clog the Appliance.
15. Do not use Appliance to pick up flammable or combustible materials such as gasoline, printer or copier toner, or use in areas where they may be present.
16. Do not use Appliance to pick up anything that is burning or smoking, such as cigarettes, matches, hot ashes, or anything that could cause a fire.
17. Do not put objects into the suction intake. Do not use if the suction intake is blocked. Keep the intake clear of dust, lint, hair, or anything that may reduce air flow.
18. Take care not to damage the power cord. Do not pull on or carry the Appliance or Charging Dock by the power cord, use the power cord as a handle, close a door on the power cord, or pull power cord around sharp edges or corners. Do not run Appliance over the power cord. Keep power cord away from hot surfaces.
19. If the power cord is damaged, it must be replaced by the manufacturer or its service agent in order to avoid a hazard.
20. Do not use the Charging Dock if it is damaged.
21. Do not use with a damaged power cord or receptacle. Do not use the Appliance or Charging Dock if it is not working properly, has been dropped, damaged, left outdoors, or come in contact with water. It must be repaired by the manufacturer or its service agent in order to avoid a hazard.

1. Important Safety Instructions

22. Turn OFF the power switch before cleaning or maintaining the Appliance.
23. The plug must be removed from the receptacle before cleaning or maintaining the Charging Dock.
24. Remove the Appliance from the Charging Dock, and turn OFF the power switch to the Appliance before removing the battery for disposal of the Appliance.
25. The battery must be removed and discarded according to local laws and regulations before disposal of the Appliance.
26. Please dispose of used batteries according to local laws and regulations.
27. Do not incinerate the Appliance even if it is severely damaged. The batteries can explode in a fire.
28. When not using the Charging Dock for a long period of time, please unplug it.
29. The Appliance must be used in accordance with the directions in this Instruction Manual. ECOVACS ROBOTICS cannot be held liable or responsible for any damages or injuries caused by improper use.

2. Package Contents and Technical Specifications

2.1 Package Contents

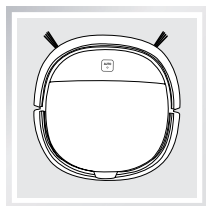

Robot

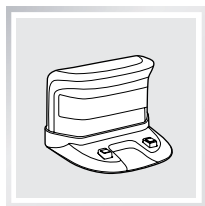

Charging Dock

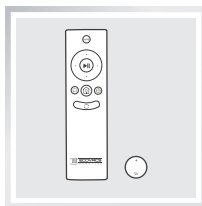

Remote Control with
Button Cell Battery



Instruction Manual

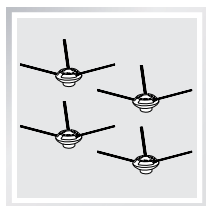

(4) Side Brushes

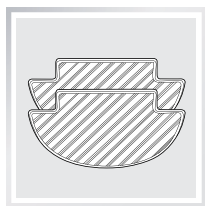

(2) Washable/Reusable
Microfiber Cleaning Cloths

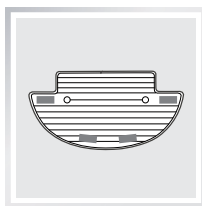

Cleaning Cloth Plate

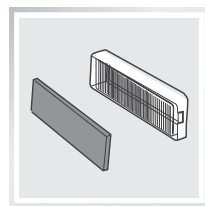

Replacement High
Efficiency Filter+
Sponge Filter

2.2 Specifications

Model	DK560/DEEBOT MINI		
Working Voltage	12V DC	Rated Power	15W
Charging Dock Model	CH1465A		
Rated Input Voltage	100-240V AC	Rated Output Voltage	20V DC
Rated Output Current	1A	Rated Power	20W
Remote Control Model	RC1521B	Input Voltage	3V DC
Battery and Specification	Ni-MH SC 1800mAh		

* Technical and design specifications may be changed in the course of continuous product improvement.

2. Package Contents and Technical Specifications

2.3 Product Diagram

Robot

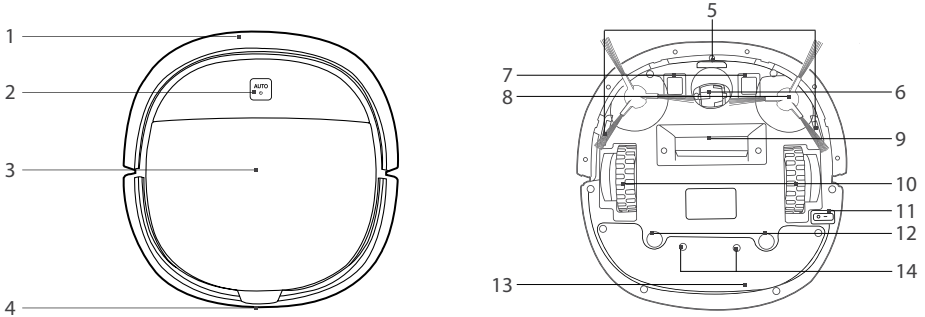

- | | |
|---|--------------------------------|
| 1. Anti-Collision Sensors | 8. Side Brushes |
| 2. Control Panel | 9. Suction Intake |
| 3. Top Cover | 10. Driving Wheels |
| 4. Infrared Receiver for Remote Control | 11. Bottom Power Switch |
| 5. Anti-Drop Sensors | 12. Cleaning Cloth Plate Slots |
| 6. Universal Wheel | 13. Battery Cover |
| 7. Charging Contacts | 14. Battery Cover Screws |

Control Panel



1. AUTO Mode Button

Charging Dock

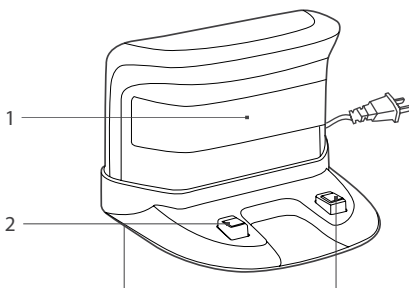

1. Infrared Signal Generators
2. Charging Dock Pins

2. Package Contents and Technical Specifications

Remote Control

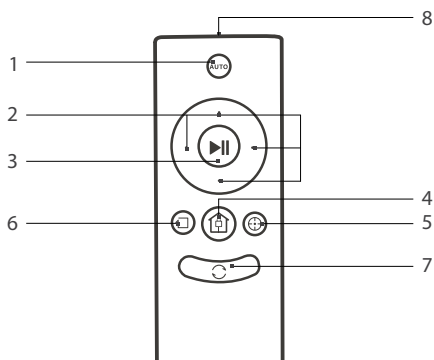

1. AUTO Mode Button
2. Direction Control Buttons
3. START/PAUSE Button
4. Return to Charger Mode Button
5. Spot Cleaning Mode Button
6. Edge Cleaning Mode Button
7. Intelligent Scheduling Button
8. Infrared Emitter

Dust Bin

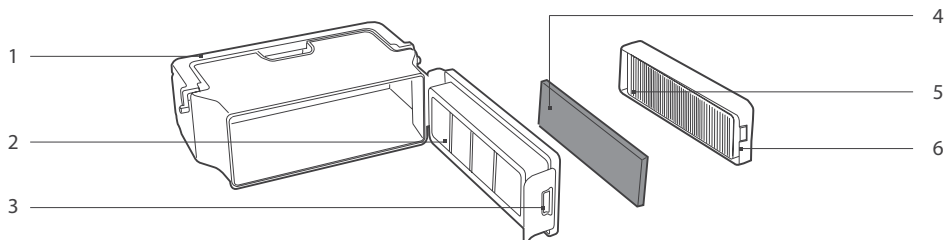

1. Dust Bin Handle
2. Filter Net
3. Dust Bin Lock
4. Sponge Filter
5. High Efficiency Filter
6. Dust Bin Cover

Washable/Reusable Microfiber Cleaning Cloth and Cleaning Cloth Plate

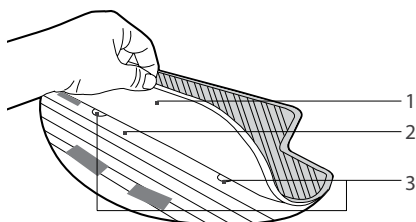

1. Washable/Reusable Microfiber Cleaning Cloth
2. Cleaning Cloth Plate
3. Cleaning Cloth Plate Tabs

3. Operating and Programming

3.1 Notes Before Cleaning

Before operating DEEBOT, take a few moments to survey the area to be cleaned and remove any obstacles.

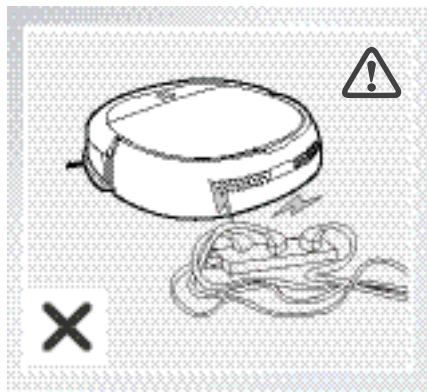

Remove power cords and small objects from the floor that could entangle the product.

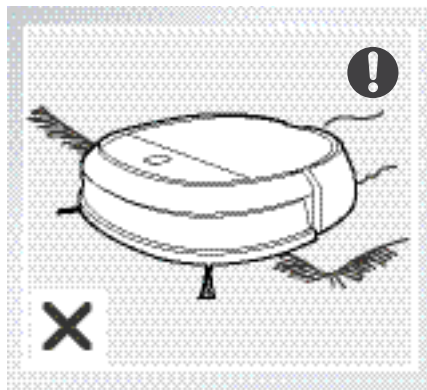

The product is not suitable for use on carpet. Before using the product near an area rug, please fold area rug edges under themselves.

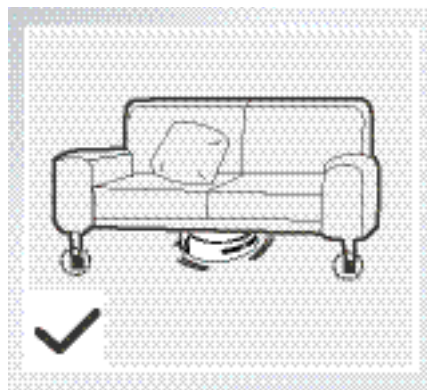

Please be aware that the robot needs at least a 9 cm (3.5") clearance to clean under furniture without complications.

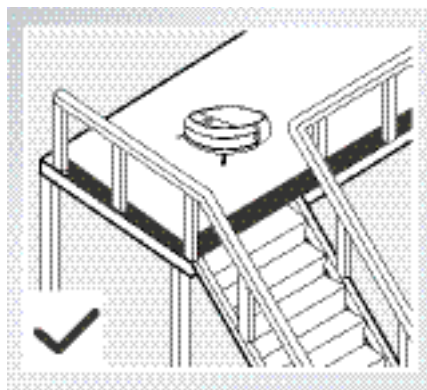

If there is a step or stairs in the cleaning area, please operate DEEBOT to ensure its Anti-Drop Sensors can detect the drop off. It may be necessary to place a physical barrier at the edge of the drop off to keep the unit from falling over the edge.

3. Operating and Programming

3.2 Quick Start

1 Charging Dock Placement

- Place the Charging Dock on a level floor surface against the wall with the base perpendicular to the ground. Keep the immediate area 1.5m (5') in front of the charger and 0.5m (1.6') on both sides of the charger clear of objects and reflective object surfaces such as mirrors etc.
- Plug the Charging Dock in.

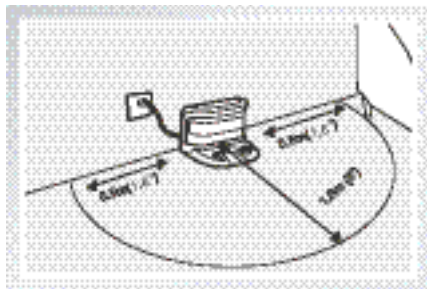

2 Install Side Brushes

- Attach Side Brushes to the bottom of DEEBOT by pressing a brush into each slot with the matching color until it clicks.

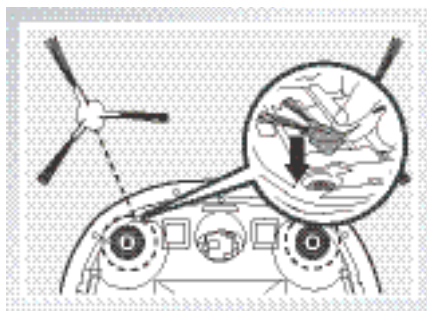

3 Power ON

- Turn the robot's Bottom Power Switch to the ON position. "I"=power ON; "O"=power OFF. DEEBOT is powered ON when the AUTO Mode Button glows a continuous BLUE.

* When DEEBOT is not cleaning, it is suggested to keep it powered ON and charging instead of powered OFF.

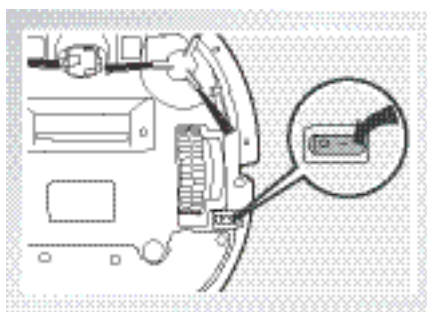

3. Operating and Programming

4 Charge DEEBOT

- Place DEEBOT on the Charging Dock making sure the Charging Contacts on DEEBOT and the Charging Dock Pins make a connection.
- Charge DEEBOT for at least 4 hours before the first use.

- * Make sure the robot's Bottom Power Switch is ON before charging.
- * AUTO Mode Button blinks when DEEBOT is charging. AUTO Mode Button stops glowing when DEEBOT is fully charged.

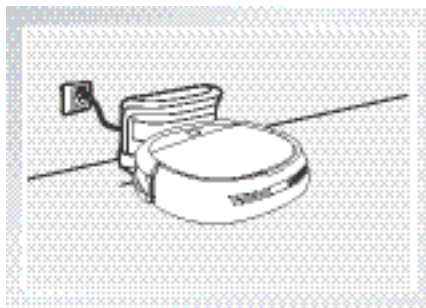

5 Attach Cleaning Cloth, if Desired

To use the robot's optional mopping feature, attach the provided Washable/Reusable Microfiber Cleaning Cloth.

- * When using the optional mopping feature, fold area rug edges under themselves so DEEBOT will avoid the rug.

Attach the Washable/Reusable Microfiber Cleaning Cloth to the Cleaning Cloth Plate. Place the square end of the Cleaning Cloth Plate inside the pocket on the Washable/Reusable Microfiber Cleaning Cloth. Smooth the white side of the Washable/Reusable Microfiber Cleaning Cloth onto the Velcro areas on the bottom of the Cleaning Cloth Plate. Ensure the blue side of the Cleaning Cloth faces out.

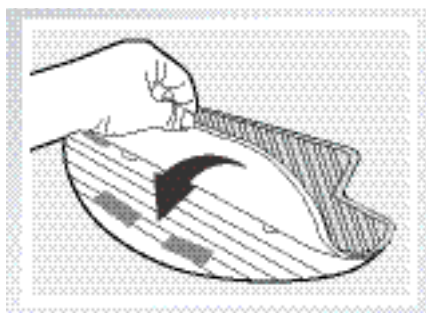

Insert the Cleaning Cloth Plate tabs into the Cleaning Cloth Plate Slots on the bottom of DEEBOT until you hear a click.

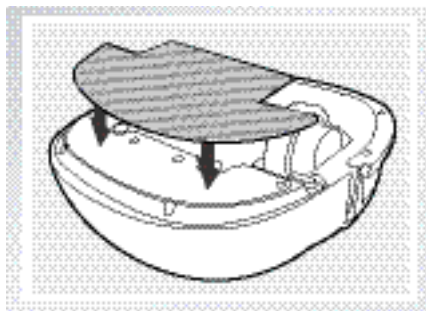

3. Operating and Programming

6 Start

- Press the AUTO Mode Button on DEEBOT or on the Remote Control. DEEBOT starts to work immediately in AUTO Cleaning Mode.

* To choose another Cleaning Mode, please refer to section 3.3 Cleaning Mode Selection for details.

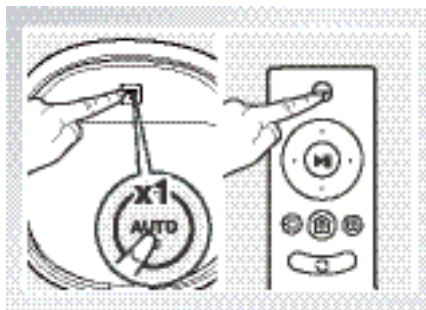

7 Pause

- Pause DEEBOT by pressing the AUTO Mode Button on DEEBOT or the START/PAUSE Button on the Remote Control.

* DEEBOT can be directed to move forward, backward, left and right using the Direction Control Buttons on the Remote Control when it is Paused. DEEBOT does not clean when Paused.

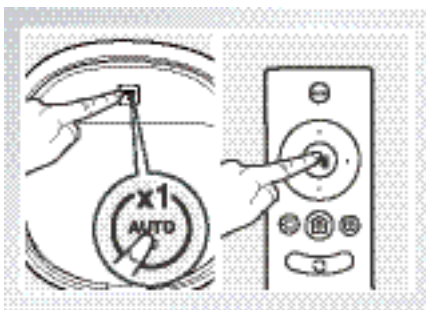

* To save power, the AUTO Mode Button on the robot's Control Panel stops glowing after the robot is paused for more than 10 minutes. Press the AUTO Mode Button on the robot to wake up the robot, or press any button on the Remote Control to start the robot immediately.

8 Power OFF

- Pause DEEBOT. Move the Bottom Power Switch to the OFF position.

* When DEEBOT is not cleaning, it is suggested to keep it powered ON and charging.

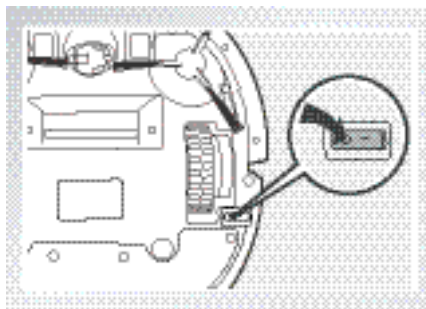

3. Operating and Programming

3.3 Cleaning Mode Selection

DEEBOT has several Cleaning Modes to choose from to effectively clean different floors. Cleaning Modes are selected with the Remote Control.

1 AUTO Cleaning Mode

This is the most commonly used mode. In AUTO Cleaning Mode, DEEBOT cleans in a straight line and changes direction when it meets an obstacle.

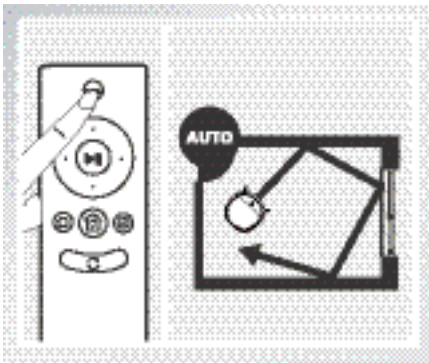

2 Edge Cleaning Mode

This mode is good for cleaning the edges and corners of a room. In Edge Cleaning Mode, DEEBOT cleans along a border (e.g. wall) and returns to the Charging Dock when it completes Edge Cleaning.

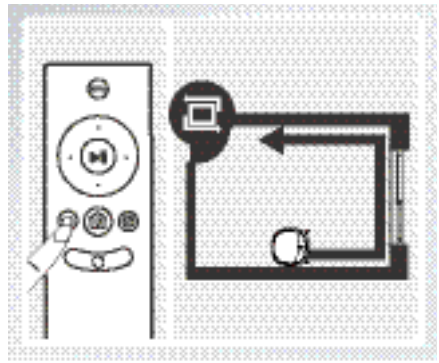

3 Spot Cleaning Mode (2-5 minutes)

This mode is applicable for an area of highly concentrated dirt or dust. In Spot Cleaning Mode, DEEBOT focuses on a specific area to clean. DEEBOT cleans the area in a spiral pattern and stops when it completes Spot Cleaning.

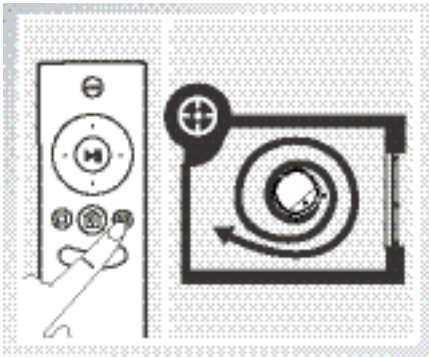

4 Return to Charger Mode

When battery power gets low, DEEBOT automatically switches to Return to Charger Mode and returns to the Charging Dock to recharge itself.

* DEEBOT can also be sent back to the Charging Dock at any time by pressing the Return to Charger Button on the Remote Control.

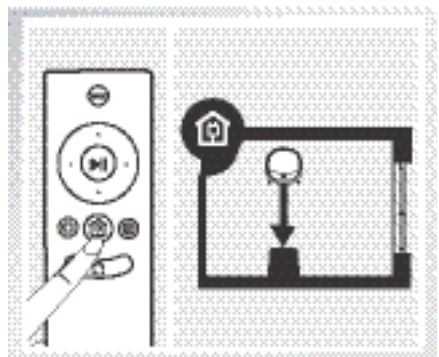

3. Operating and Programming

3.4 Intelligent Scheduling

DEEBOT has an Intelligent Scheduling function. DEEBOT can be scheduled to clean once per day at the same time, even if nobody is at home.

* All scheduled cleanings are performed in AUTO Cleaning Mode.

1 Set Intelligent Scheduling

Press the Auto Mode Button on DEEBOT twice or press the Intelligent Scheduling Button on the Remote Control to set the current time as the scheduled cleaning time. Intelligent Scheduling is set when the robot emits 2 beeps. DEEBOT will automatically clean at the set time every day.

For example: Set Intelligent Scheduling successfully at 9:00am, and DEEBOT automatically cleans at 9:00am every day.

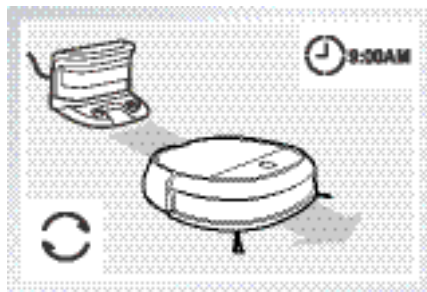
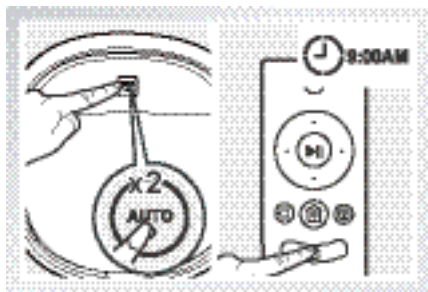

2 Cancel Intelligent Scheduling

Press the Auto Mode Button on DEEBOT twice or press the Intelligent Scheduling Button on the Remote Control. Intelligent Scheduling is cancelled when the robot emits 3 beeps.

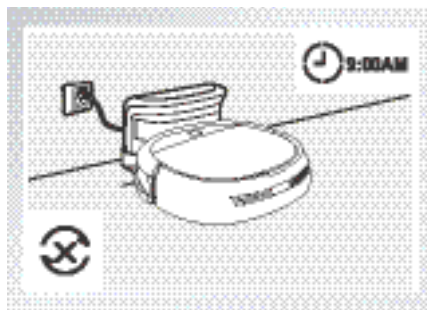
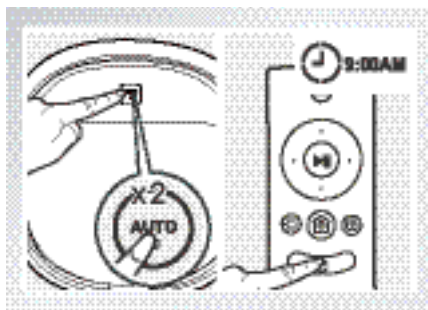

* To automatically clean at another time, first cancel the current Intelligent Scheduling, then set Intelligent Scheduling again at the desired time.

* If DEEBOT is powered OFF, Intelligent Scheduling is cancelled.

3. Operating and Programming

3.5 Alarm Indicator and Sounds

If DEEBOT detects a problem and needs your assistance, it emits alarm beeps and the AUTO Mode Button flashes RED.

Alarm Sound	Problems	Solution
One Beep	Driving Wheel Malfunction	Check Driving Wheels for tangled hair or debris and clean as described in section 4 Maintenance.
Three Beeps	Driving Wheel Malfunction	Turn over the robot. Press Driving Wheels to check for a clicking sound. If they do not click, please contact Customer Service.
	DEEBOT gets into trouble while working.	Manually remove the obstacles and restart DEEBOT.
Four Beeps	Dust Bin Malfunction	Remove the Dust Bin and re-install it properly. If the robot still emits the alarm, please contact Customer Service.
Five Beeps	Low Battery	Manually place the robot on the Charging Dock to charge.
Six Beeps	Side Brush Malfunction	Check Side Brushes for tangled hair or debris and clean as described in section 4 Maintenance.
Seven Beeps	Anti-Drop Sensor Malfunction	Check Anti-Drop Sensors for dust and clean as described in section 4 Maintenance.

4. Maintenance

* Before performing cleaning and maintenance, power OFF DEEBOT and unplug the Charging Dock.

4.1 Dust Bin and Filters

Open the robot's Top Cover and remove the Dust Bin. Open the Dust Bin Lock and empty the Dust Bin.

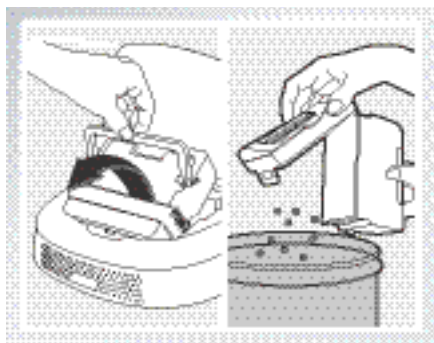

Remove the filters. Pat the High Efficiency Filter clean. Do not rinse the High Efficiency Filter under water.

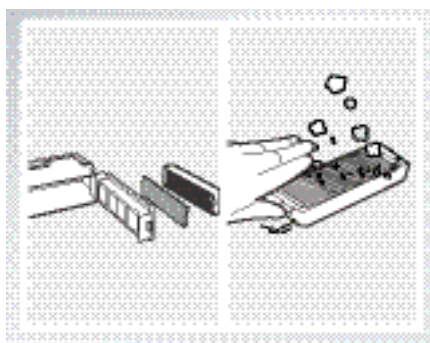

Rinse the Dust Bin, Filter Net and Sponge Filter under running water.

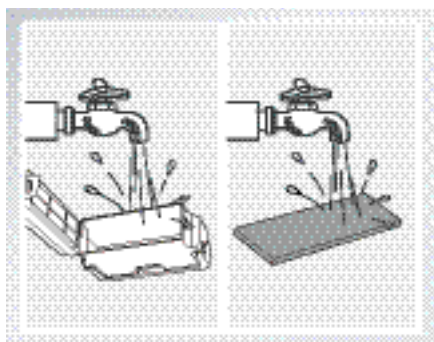

Dry the Dust Bin and filters completely before reinstalling.

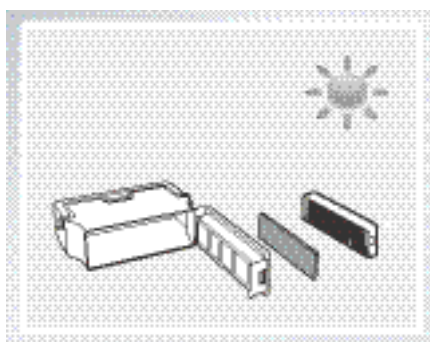

4. Maintenance

4.2 Washable/Reusable Microfiber Cleaning Cloth and Cleaning Cloth Plate

Remove the Cleaning Cloth Plate from DEEBOT and remove the Cleaning Cloth.

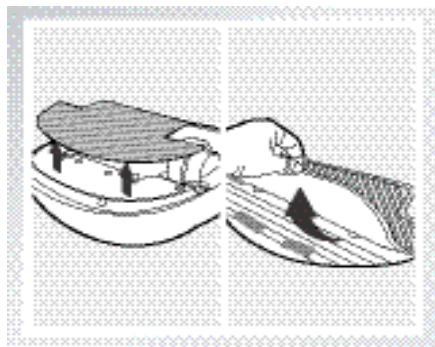

Wash the Cleaning Cloth by hand, and lay flat to dry.

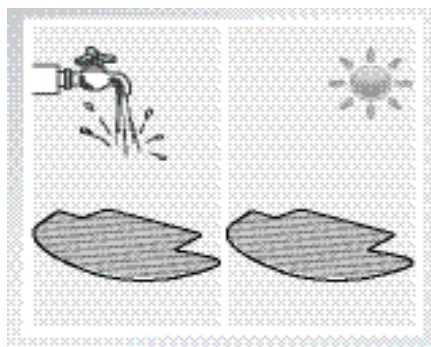

Wipe the Cleaning Cloth Plate with a dry cloth.

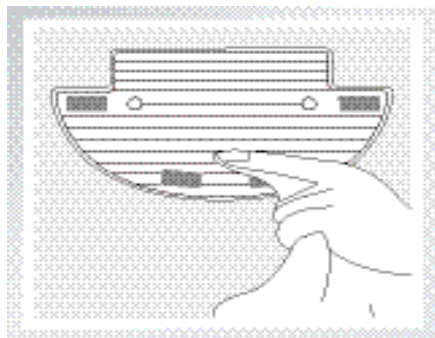

4. Maintenance

4.3 Suction Intake and Side Brushes

Wipe the Suction Intake with a dry cloth.

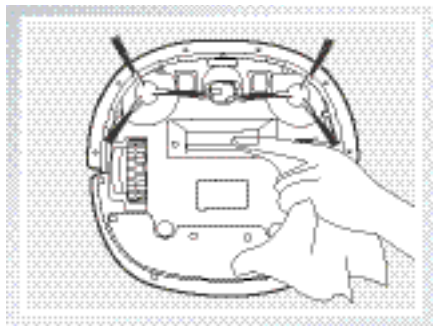

Remove the Side Brushes and wipe the Side Brushes and their slots with a clean cloth.

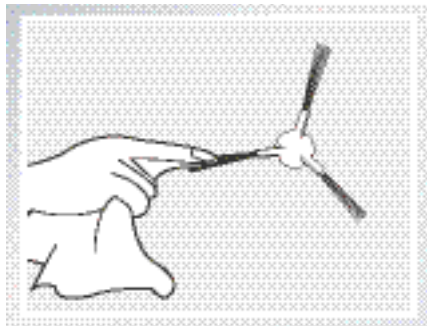

4.4 Other Components

Clean the Universal Wheel by removing any hair tangled around it.

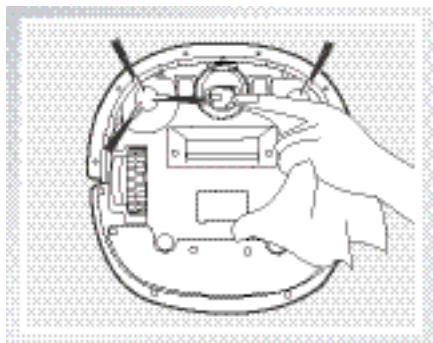

Wipe the Anti-Drop Sensors with a dry cloth to maintain their effectiveness.

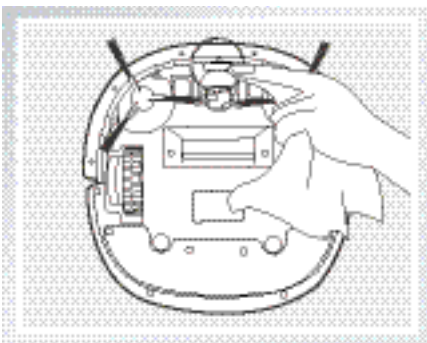

Wipe the Charging Contacts and the Charging Docks Pins with a dry cloth to maintain their effectiveness.

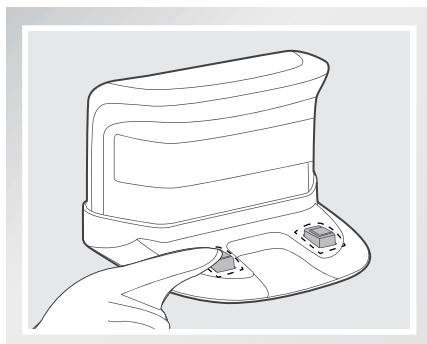
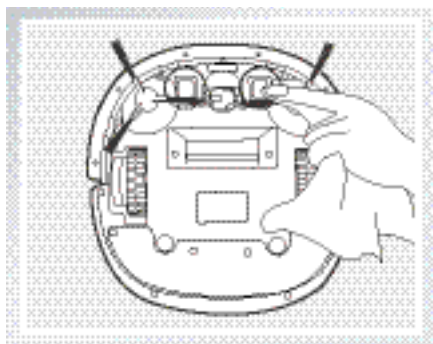

5. Troubleshooting

Please use this chart to troubleshoot common problems using DEEBOT.

No.	Malfunction	Possible Causes	Solutions
1	DEEBOT will not charge.	DEEBOT is not powered ON. DEEBOT will not charge unless it is powered ON while on the Charging Dock even if the AUTO Mode Button is flashing.	Move the robot's Bottom Power Switch to the ON position.
		DEEBOT has not made a connection with the Charging Dock.	Be sure that the robot's Charging Contacts have made a connection with the Charging Dock Pins. You may move the robot manually to make the connection if necessary.
		The Charging Dock is unplugged while DEEBOT is powered ON, which causes battery consumption.	Plug in the Charging Dock and ensure DEEBOT is powered ON. Keep DEEBOT on the Charging Dock to make sure it has full battery to work at any time.
		The battery is completely discharged.	Re-activate the battery. Place DEEBOT on the Charging Dock by hand, remove after charging for 3 minutes, repeat 3 times; then charge normally.
2	DEEBOT gets into trouble while working and stops.	DEEBOT is tangled with something on the floor (electrical cords, drooping curtains, area rug fringe etc.).	DEEBOT will try various ways to get itself out of trouble. If it is unsuccessful, manually remove the obstacles and restart.
3	DEEBOT returns to the Charging Dock before it finishes cleaning.	When battery power gets low, DEEBOT automatically switches to Return to Charger Mode and returns to the Charging Dock to recharge itself.	This is normal. No solution necessary.
		Working time varies according to floor surface, room complexity and the selected Cleaning Mode.	This is normal. No solution necessary.

5. Troubleshooting

No.	Malfunction	Possible Causes	Solutions
4	DEEBOT will not clean automatically at scheduled time.	Intelligent Scheduling function is cancelled.	Please refer to section 3.4 Intelligent Scheduling Function for details.
		DEEBOT is powered OFF.	Power ON DEEBOT.
		The robot's battery is low.	Keep DEEBOT powered ON and on the Charging Dock to make sure it has full battery to work at any time.
		The robot's Suction Intake is blocked and/or its components are tangled with debris.	Turn the robot's power OFF, clean the Dust Bin and invert the robot. Clean the robot's Suction Intake and Side Brushes.
5	Remote Control failure (Effective control range of the Remote Control is 5m (16').	The battery in the Remote Control needs to be replaced.	Replace with a new battery making sure it is installed correctly.
		DEEBOT is powered OFF or the robot's battery is low.	Make sure DEEBOT is powered ON and fully charged.
		The infrared signal cannot be transmitted because the Infrared Emitter on Remote Control or the Infrared Receiver on DEEBOT is dirty.	Use clean dry cloth to wipe the Infrared Emitter on Remote Control and the Infrared Receiver on DEEBOT.
		There is other equipment interfering with the infrared signal to DEEBOT.	Avoid using the Remote Control near other equipment using infrared signals.

